

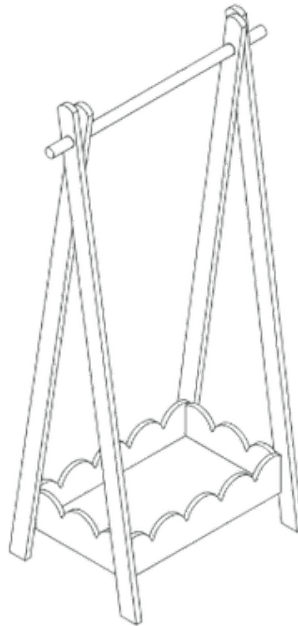

Alice & Fox



Dune Clothes Rack



IMPORTANT! READ CAREFULLY AND KEEP FOR FUTURE REFERENCE.

Model: Alice & Fox Dune Clothes Rack (SHIDA25022)

EN71-1:2014+A1:2018 & EN71-3:2019+A1:2021



WARNINGS

IMPORTANT! READ CAREFULLY AND KEEP FOR FUTURE REFERENCE.

WARNING Do not place the product near a window as it can be used as a step and can cause a child to fall out of the window.

WARNING Do not place this product near a window where cords from blinds or curtains could strangle a child.

WARNING Do not allow children to climb on the product.

WARNING To prevent tipping, the product must be fixed to the wall.

- Adult assembly required.
- Be aware of the risk of open fires and other sources of strong heat in the vicinity of the product.
- All assembly fittings should be checked regularly and retightened as necessary.
- DO NOT use the product if any part is broken, damaged, or missing. Contact Jollyroom AB for inquiries about spare parts and instructions if needed. DO NOT replace parts with anything other than those recommended by the manufacturer.
- The maximum load is 5 kg on the clothes rail and 10 kg in the bottom box.
- Recommended age: 3-6 years.
- Cleaning instructions: Clean by wetting towel with water and wring it out.



PARTS

Note! Do not use an electric screw driver.

A x1

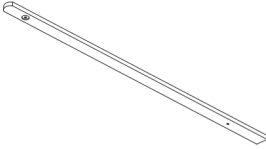

B x1

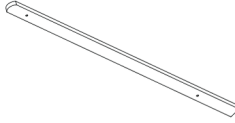

C x1

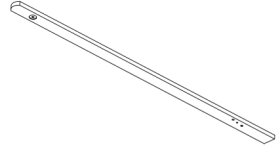

D x1

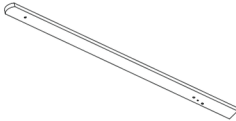

E x2

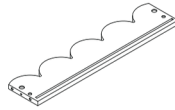

F x2



G x1

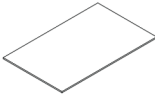

H x1

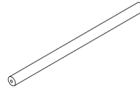

I x2



x5



x5



x9

Ø6*30mm



x5

Ø4*30mm

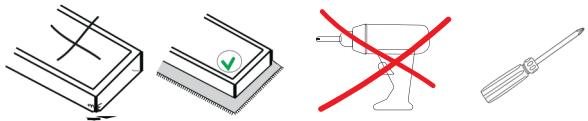

Fall-off/Tilting Prevention Parts

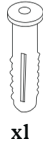

WARNING To prevent this furniture from tipping over, it must be permanently fixed to the wall.

The package includes fastening devices suitable for concrete or solid brick walls only. If your wall is made of a different material, or if you are unsure about the wall construction, consult a qualified professional before installation.

ASSEMBLY INFORMATION

Before final assembly, insert all screws into their holes and tighten them lightly. Tighten each screw to approximately 70–80% only. Do not fully tighten any screw until all screws have been installed and all parts are correctly aligned. Once assembly is complete and all components are properly positioned, tighten all screws fully to 100%.

If you encounter any difficulties during assembly, such as holes not aligning or parts being difficult to fit, do not force the parts into place. Check that the correct screws are being used and slightly loosen the surrounding screws to allow adjustment, then try again.

If the legs are uneven after assembly, loosen the screws slightly and adjust the legs so that all feet rest evenly and horizontally on the ground. Once the product is stable and level, tighten the screws securely.

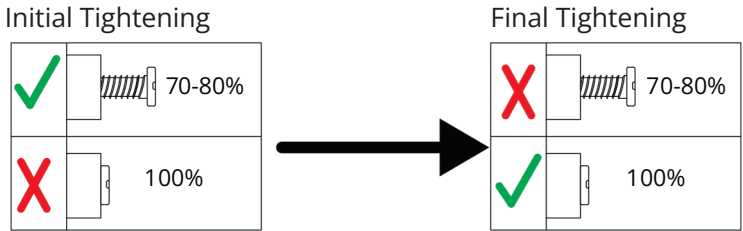

VARNINGAR

VIKTIGT! LÄS NOGA OCH SPARA FÖR FRAMTIDA BRUK.

VARNING Placera inte produkten nära ett fönster eftersom den kan användas som en trappsteg och orsaka att ett barn faller ut genom fönstret.

VARNING Placera inte produkten nära ett fönster där gardin- eller persiennsnören kan strypa ett barn.

VARNING Låt inte barn klättra på produkten.

VARNING För att förhindra att produkten tippas måste den fästas i väggen.

- Montering av vuxen krävs.
- Var uppmärksam på risken för öppen eld och andra starka värmekällor i närheten av produkten.
- Alla monteringsbeslag bör kontrolleras regelbundet och dras åt vid behov.
- Använd INTE produkten om någon del är trasig, skadad eller saknas. Kontakta Jollyroom AB för förfrågningar om reservdelar och instruktioner vid behov. Byt INTE ut delar mot något annat än de som rekommenderas av tillverkaren.
- Maximal belastning är 5 kg på klädstången och 10 kg i bottenlådan.
- Rekommenderad ålder: 3-6 år.
- Rengöringsanvisningar: Rengör med en fuktig trasa som har vridits ur.

DELAR

Obs! Använd inte en elektrisk skruvdragare.

A x1

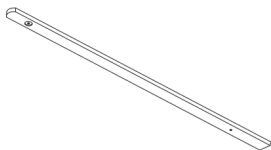

B x1

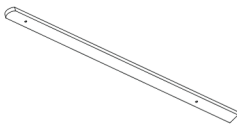

C x1

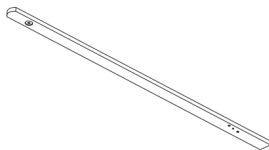

D x1

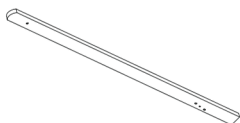

E x2



F x2



G x1

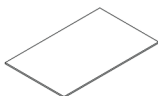

H x1

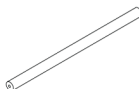

I x2



x5



x5



x9



x5

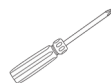
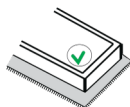
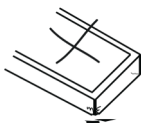

Anordningar för att förhindra fall och tippning



x1



x1

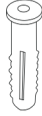

x1

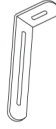

x1



x2

VARNING För att förhindra att möbeln välter måste den fästas permanent i väggen.

Förpackningen innehåller fästeanordningar som endast är lämpliga för betong- eller tegelväggar. Om din vägg är tillverkad av ett annat material, eller om du är osäker på väggens konstruktion, ska du rådfråga en kvalificerad fackman före installationen.

MONTERINGSINFORMATION

Före slutmontering ska alla skruvar föras in i sina hål och dras åt lätt. Dra endast åt varje skruv till cirka 70-80%. Dra inte åt någon skruv helt förrän alla skruvar har installerats och alla delar är korrekt inriktade. När monteringen är klar och alla komponenter är korrekt placerade, dra åt alla skruvar helt till 100%.

Om du stöter på problem under monteringen, t.ex. att hålen inte passar ihop eller att delarna är svåra att få på plats, ska du inte tvinga delarna på plats. Kontrollera att rätt skruvar används och lossa de omgivande skruvarna något för att möjliggöra justering och försök sedan igen.

Om benen är ojämna efter montering, lossa skruvarna något och justera benen så att alla fötter vilar jämnt och horisontellt på marken. När produkten är stabil och i linje drar du åt skruvarna ordentligt.

Initial åtdragning

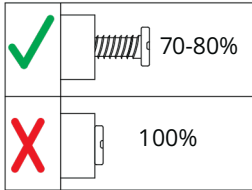

Slutlig åtdragning

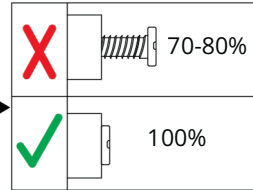

ADVARSLER

VIKTIG! LES NØYE OG OPPBEVAR FOR FREMTIDIG REFERANSE.

ADVARSEL Ikke plasser produktet i nærheten av et vindu, da det kan brukes som et trinn og føre til at et barn faller ut av vinduet.

ADVARSEL Ikke plasser produktet i nærheten av et vindu hvor snorer fra gardiner eller persienner kan kvele et barn.

ADVARSEL Ikke la barn klatre på produktet.

ADVARSEL For å forhindre at produktet velter, må det festes til veggen.

- Må monteres av en voksen.
- Vær oppmerksom på risikoen for åpen ild og andre sterke varmekilder i nærheten av produktet.
- Alle monteringsbeslag bør kontrolleres regelmessig og strammes ved behov.
- IKKE bruk produktet hvis noen del er ødelagt, skadet eller mangler. Kontakt Jollyroom AB for å få informasjon om reservedeler og instruksjoner ved behov. IKKE bytt ut deler med noe annet enn de som er anbefalt av produsenten.
- Maksimal belastning er 5 kg på klesstangen og 10 kg i bunnboksen.
- Anbefalt alder: 3-6 år.
- Rengjøringsinstruksjoner: Rengjør med en fuktig klut som er vridd opp.

DELER

Merk! Ikke bruk elektrisk skrutrekker.

A x1

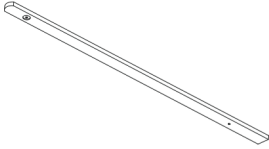

B x1

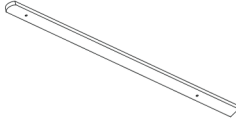

C x1

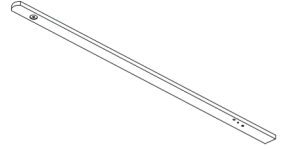

D x1

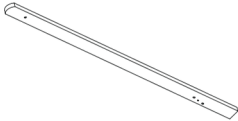

E x2

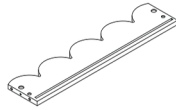

F x2



G x1

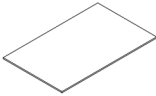

H x1

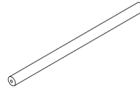

I x2



x5



x5



x9

Ø6*30mm



x5

Ø4*30mm

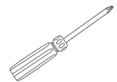
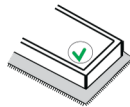
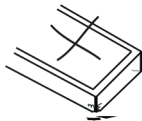



Festeanordninger for å forhindre fall og tipping



x1



x1

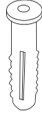

x1



x1



x2

ADVARSEL For å forhindre at møbelet velter, må det festes permanent til vegg.

Pakken inneholder festeanordninger som kun er egnet for betong- eller mursteinsvegger. Hvis veggene er laget av et annet materiale, eller du er usikker på veggkonstruksjonen, må du rådføre deg med en kvalifisert fagperson før montering.

MONTERINGS INFORMASJON

Før sluttmontering, sett alle skruene inn i hullene og stram dem lett til. Trekk til hver skrue til ca. 70-80 %. Ikke stram noen av skruene helt til før alle skruene er montert og alle delene er riktig innrettet. Når monteringen er fullført og alle komponentene er riktig plassert, strammer du alle skruene helt til 100 %.

Hvis du støter på problemer under monteringen, for eksempel at hullene ikke flukter eller at delene er vanskelige å få på plass, må du ikke tvinge delene på plass. Kontroller at de riktige skruene er brukt, og løsne litt på skruene rundt for å muliggjøre justering, og prøv deretter på nytt.

Hvis bena er ujevne etter montering, løsner du skruene litt og justerer bena slik at alle føttene hviler jevnt og vannrett på underlaget. Når produktet er stabilt og i vater, strammer du skruene godt til.

Innledende innstramming

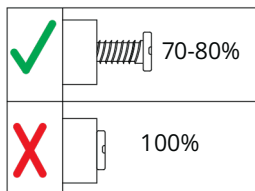

Endelig stramming

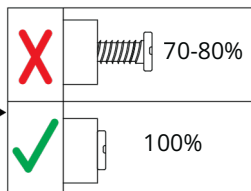

ADVARSLER

VIGTIGT! LÆS OMHYGGELIGT OG GEM TIL SENERE BRUG.

ADVARSEL Placer ikke produktet i nærheden af et vindue, da det kan bruges som en trin og forårsage, at et barn falder ud ad vinduet.

ADVARSEL Placer ikke produktet i nærheden af et vindue, hvor snore fra gardiner eller persienner kan udgøre en kvælningssrisiko for et barn.

ADVARSEL Lad ikke børn klatre op på produktet.

ADVARSEL For at undgå, at produktet vælter, skal det fastgøres til væggen.

- Skal samles af en voksen.
- Vær opmærksom på risikoen for åben ild og andre stærke varmekilder i nærheden af produktet.
- Alle monteringsbeslag bør kontrolleres regelmæssigt og efterspændes efter behov
- Brug IKKE produktet, hvis nogen del er ødelagt, beskadiget eller mangler. Kontakt Jollyroom AB for forespørgsler om reservedele og instruktioner, hvis det er nødvendigt. Udskift IKKE dele med andet end det, der er anbefalet af producenten.
- Maksimal belastning er 5 kg på tøjstangen og 10 kg i bundkassen.
- Anbefalet alder: 3-6 år.
- Rengøringsinstruktioner: Rengør med en opvredet, fugtig klud.

DELE

Bemærk! Brug ikke en elektrisk skruetrækker.

A x1

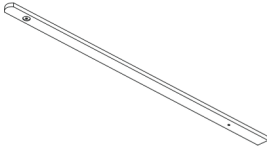

B x1

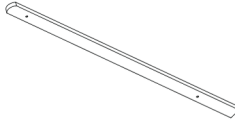

C x1

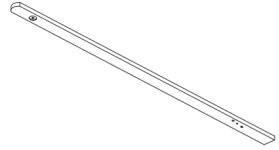

D x1

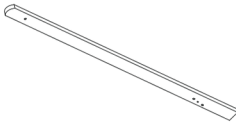

E x2

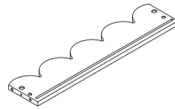

F x2



G x1

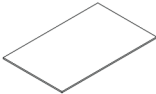

H x1

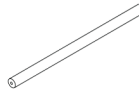

I x2



x5



x5



x9



x5

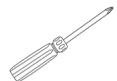
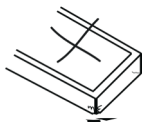

Anordninger til forhindring af fald og væltning

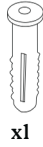

ADVARSEL For at undgå, at dette møbel vælter, skal det fastgøres permanent til væggen.

Pakken indeholder fastgørelsesanordninger, der kun er egnet til beton eller massive murstensvægge. Hvis din væg er lavet af et andet materiale, eller hvis du er usikker på vægkonstruktionen, skal du kontakte en kvalificeret fagmand før installation.

MONTERINGS VEJLEDNING

Inden den endelige samling skal alle skruer sættes i deres huller og spændes let. Spænd hver skrue til ca. 70–80 %. Ingen skruer må spændes helt, før alle skruer er monteret, og alle dele er korrekt justeret. Når samlingen er færdig, og alle komponenter sidder rigtigt, spændes alle skruer helt til 100 %.

Hvis problemer opleves under samlingen, f.eks. at huller ikke passer sammen, eller at dele er svære at montere, må delene ikke tvinges på plads. Kontrollér, at de korrekte skruer sidder i de korrekte huller, og løs de omkringliggende skruer en anelse for at give mulighed for justering, og prøv derefter igen.

Hvis benene er ujævne efter samling, løsnes skruerne let, og benene justeres, så alle fødder står jævnt og vandret på gulvet. Når produktet står stabilt og i vater, spændes skruerne grundigt.

Foreløbig tilspænding

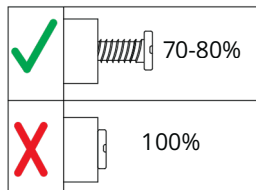

Endelig tilspænding

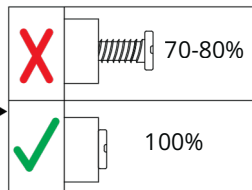

VAROITUKSET

TÄRKEÄÄ! LUE HUOLELLISESTI JA SÄILYÄ MYÖHEMPÄÄ KÄYTTÖÄ VARTEN.

VAROITUS Älä sijoita tuotetta ikkunan lähelle, koska sitä voidaan käyttää askelmana, mikä voi johtaa lapsen putoamiseen ikkunasta.

VAROITUS Älä sijoita tuotetta ikkunan lähelle, jossa verhojen tai kaihtimien narut voivat aiheuttaa kuristumisvaaran lapselle.

VAROITUS Älä anna lasten kiivetä tuotteen päälle.

VAROITUS Kaatumisen estämiseksi tuote on kiinnitettävä seinään.

- Tuote tulee koota aikuisen toimesta.
- Ole tietoinen avoimen tulen ja muiden voimakkaiden lämmönlähteiden aiheuttamasta riskistä tuotteen läheisyydessä.
- Kaikki kiinnikkeet tulisi tarkistaa säännöllisesti ja kiristää tarvittaessa.
- ÄLÄ käytä tuotetta, jos jokin osa on rikki, vaurioitunut tai puuttuu. Ota tarvittaessa yhteyttä Jollyroom AB:hen varaosia ja ohjeita koskevista tiedusteluista. ÄLÄ korvaa osia muilla kuin valmistajan suosittelemilla osilla.
- Suurin sallittu kuormitus on 5 kg vaatetangolla ja 10 kg pohjalaatikossa.
- Suositusikä: 3-6 vuotta.
- Puhdistusohjeet: Puhdista kostealla, hyvin väännetyllä liinalla.

OSAT

Huom! Älä käytä sähköruuvimeisseliä.

A x1

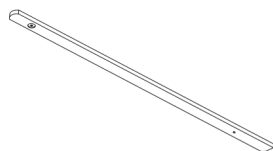

B x1

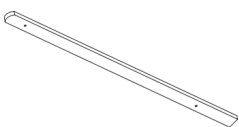

C x1

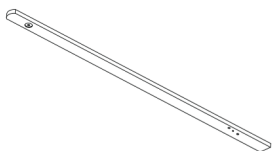

D x1

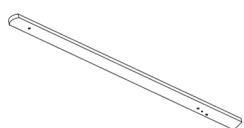

E x2

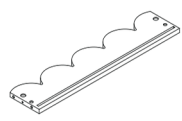

F x2

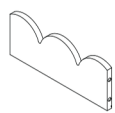

G x1

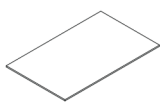

H x1

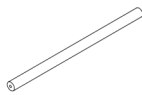

I x2



x5



x5



Ø6*30mm
x9



Ø4*30mm
x5

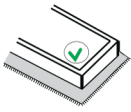
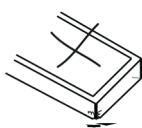

Kaatumisen/kallistumisen estolaitteet



x1



x1

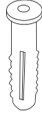

x1

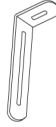

x1



x2

VAROITUS Kaatumisen estämiseksi kaluste on kiinnitettävä pysyvästi seinään.

Pakkaus sisältää kiinnitystarvikkeet, jotka soveltuvat ainoastaan betoni- tai täystiiliseinille. Jos seinäsi on valmistettu muusta materiaalista tai et ole varma seinärakenteesta, ota yhteyttä pätevään ammattilaiseen ennen asennusta.

KOKOAMISOHJEET

Aseta kaikki ruuvit reikiinsä ja kiristä ne kevyesti ennen lopullista kokoamista. Kiristä jokainen ruuvi vain noin 70-80 %. Älä kiristä ruuveja kokonaan, ennen kuin kaikki ruuvit on asennettu ja kaikki osat on kohdistettu oikein. Kun kokoonpano on valmis ja kaikki osat ovat oikeassa asennossa, kiristä kaikki ruuvit kokonaan 100 %.

Jos kokoamisen aikana ilmenee vaikeuksia, kuten reikien kohdistus ei onnistu tai osia on vaikea sovittaa yhteen, älä pakota osia paikoilleen. Tarkista, että käytät oikeita ruuveja, löysää hieman ympäröiviä ruuveja säätämisen mahdollistamiseksi ja yritä sitten uudelleen.

Jos jalat ovat kokoonpanon jälkeen epätasaiset, löysää ruuveja hieman ja säädä jalat niin, että kaikki jalat asettuvat tasaisesti ja vaakasuorasti maahan. Kun tuote on vakaa ja tasainen, kiristä ruuvit tiukasti.

Alkuperäinen kiristäminen

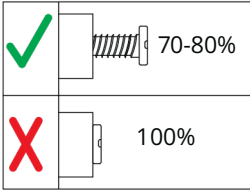

Lopullinen kiristys

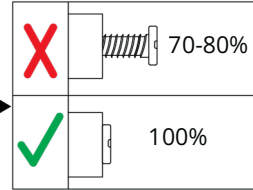

WARNUNGEN

WICHTIG! SORGFÄLTIG LESEN UND FÜR SPÄTERE VERWENDUNG AUFBEWAHREN.

WARNUNG Stellen Sie das Produkt nicht in Fensternähe auf, da es als Tritt verwendet werden kann und ein Kind aus dem Fenster fallen könnte.

WARNUNG Stellen Sie das Produkt nicht in die Nähe eines Fensters, wo Schnüre von Jalousien oder Vorhängen ein Kind strangulieren könnten.

WARNUNG Erlauben Sie Kindern nicht, auf das Produkt zu klettern.

WARNUNG Um ein Umkippen zu verhindern, muss das Produkt an der Wand befestigt werden.

- Die Montage muss durch einen Erwachsenen erfolgen.
- Achten Sie auf die Gefahr offener Flammen und anderer starker Wärmequellen in der Nähe des Produkts.
- Alle Montageteile sollten regelmäßig überprüft und bei Bedarf nachgezogen werden
- Benutzen Sie das Produkt NICHT, wenn ein Teil gebrochen oder beschädigt ist oder fehlt. Wenden Sie sich bei Bedarf an Jollyroom AB, um Ersatzteile und Anleitungen anzufordern. Ersetzen Sie KEINE Teile mit etwas anderem als den vom Hersteller empfohlenen Teilen.
- Die maximale Belastung beträgt 5 kg an der Kleiderstange und 10 kg in der Bodenbox.
- Empfohlenes Alter: 3-6 Jahren.
- Reinigungshinweise: Mit einem feuchten, gut ausgewringenen Tuch reinigen.

TEILE

Hinweis! Verwenden Sie keinen elektrischen Schraubendreher.

A x1

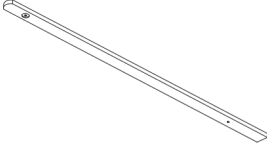

B x1

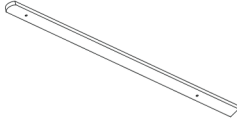

C x1

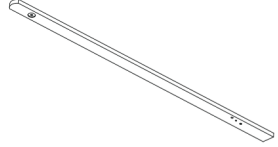

D x1

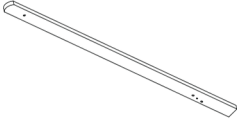

E x2

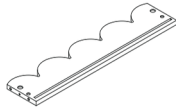

F x2

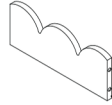

G x1

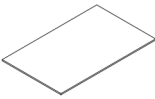

H x1

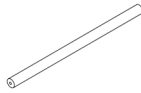

I x2



x5



x5



Ø6*30mm

x9



Ø4*30mm

x5

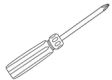
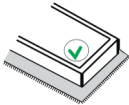
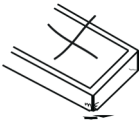

Vorrichtungen zur Verhinderung des Herunterfallens/Kippens



x1



x1

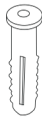

x1



x1



x2

WARNUNG Um ein Umkippen dieses Möbels zu verhindern, muss es dauerhaft an der Wand befestigt werden.

Im Lieferumfang sind Befestigungsvorrichtungen enthalten, die nur für Beton- oder Vollziegelwände geeignet sind. Wenn Ihre Wand aus einem anderen Material besteht oder wenn Sie sich über die Wandkonstruktion unsicher sind, wenden Sie sich vor der Installation an einen qualifizierten Fachmann.

MONTAGEHINWEISE

Setzen Sie vor der endgültigen Montage alle Schrauben in ihre Löcher ein und ziehen Sie sie leicht an. Ziehen Sie jede Schraube nur zu etwa 70-80% an. Ziehen Sie keine Schraube vollständig an, bevor nicht alle Schrauben angebracht und alle Teile korrekt ausgerichtet sind. Wenn die Montage abgeschlossen ist und alle Teile richtig positioniert sind, ziehen Sie alle Schrauben zu 100 % an.

Wenn Sie bei der Montage auf Schwierigkeiten stoßen, z. B. wenn die Löcher nicht fluchten oder sich die Teile nur schwer einpassen lassen, drücken Sie die Teile nicht mit Gewalt an ihren Platz. Vergewissern Sie sich, dass die richtigen Schrauben verwendet werden, lösen Sie die umliegenden Schrauben leicht, um eine Anpassung zu ermöglichen, und versuchen Sie es dann erneut.

Wenn die Beine nach dem Zusammenbau uneben sind, lösen Sie die Schrauben leicht und stellen Sie die Beine so ein, dass alle Füße gleichmäßig und waagrecht auf dem Boden stehen. Sobald das Produkt stabil und waagrecht ist, ziehen Sie die Schrauben fest an.

Erstes Anziehen

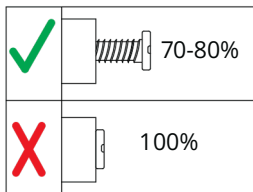

Endgültiges Festziehen

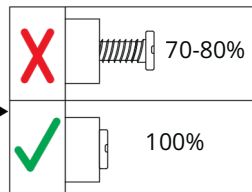

ASSEMBLY INSTRUCTIONS

MONTERING/ASENNUS/MONTAGE

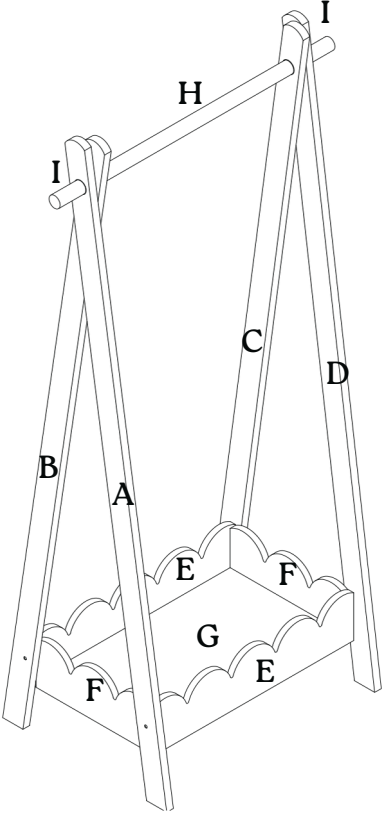

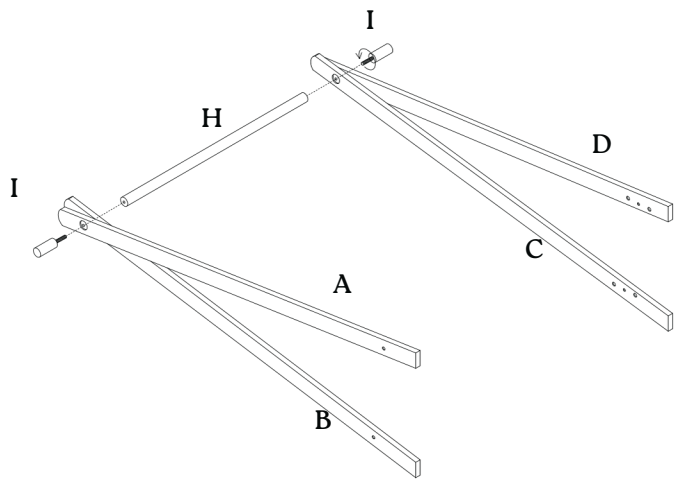

1

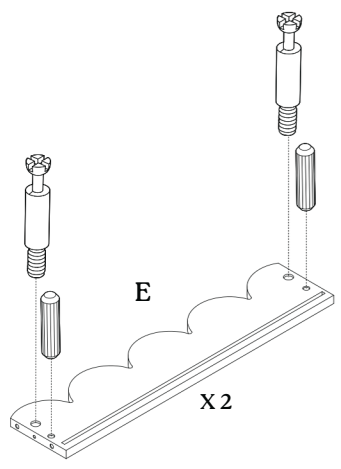

2



$\text{\O}6*35\text{mm}$

 x 4

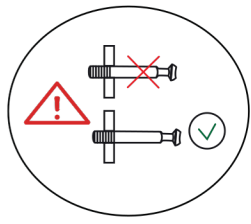
 $\text{\O}6*30\text{mm}$

 x 4

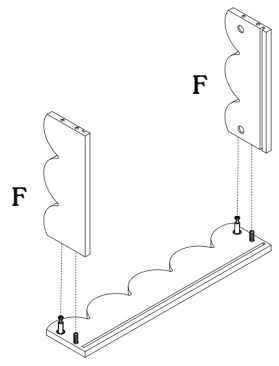

3

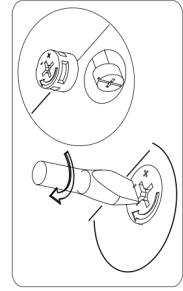
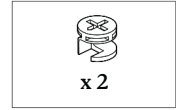
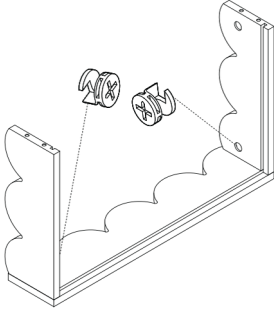

4



5

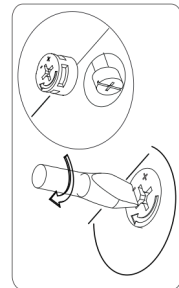
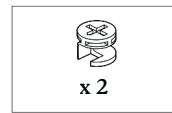
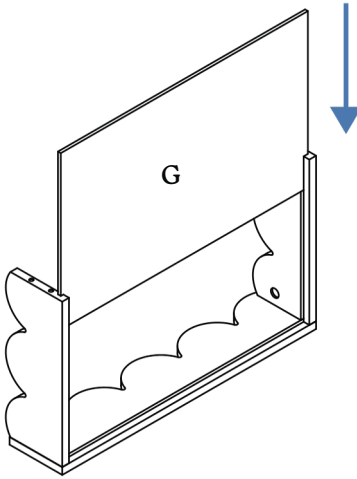

6

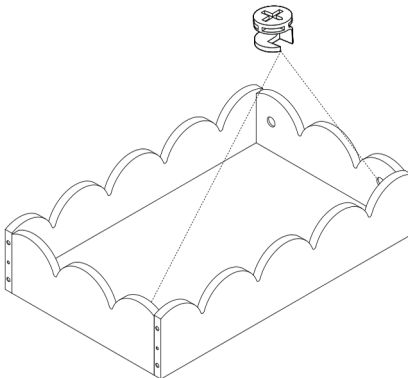

7

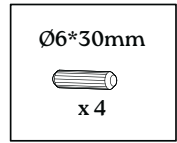
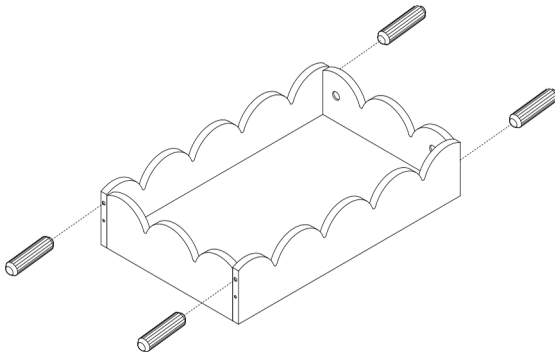

8

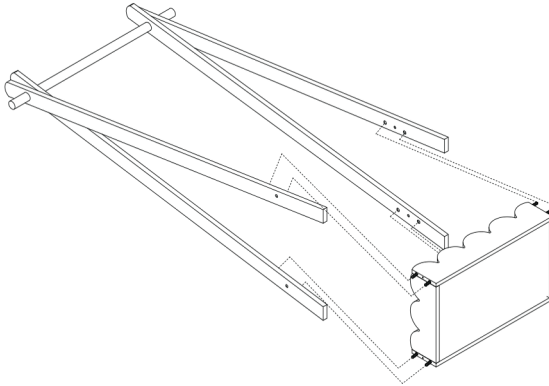

9

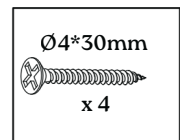
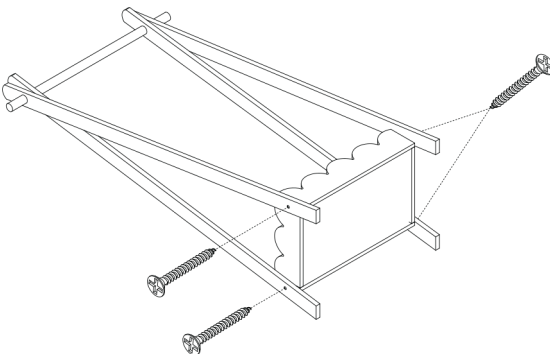

1

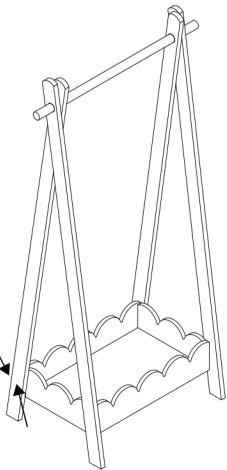
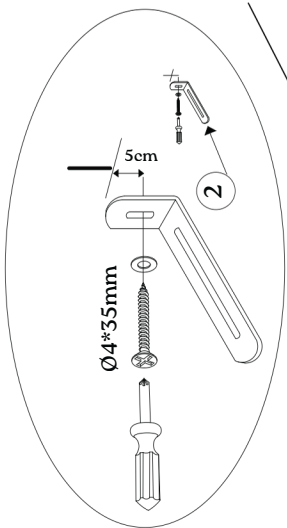
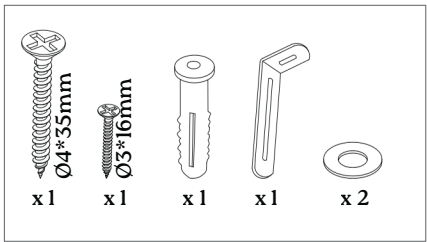
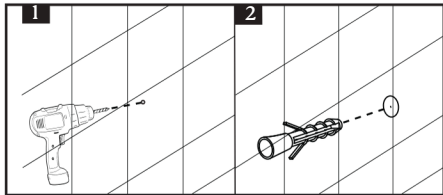



Alice & Fox



Produced by:
Jollyroom AB
Sörredsvägen III SE-418 78
Göteborg SWEDEN
Contact: +46313100000
www.jollyroom.com/contact



Producerad av:
Jollyroom AB
Sörredsvägen III SE-418 78
Göteborg SWEDEN
Kontakt: +46313100000
www.jollyroom.com/contact



Produsert av:
Jollyroom AB
Sörredsvägen III SE-418 78
Göteborg SWEDEN
Kontakt: +4733509350
www.jollyroom.com/contact



Produceret af:
Jollyroom AB
Sörredsvägen III SE-418 78
Göteborg SWEDEN
Kontakt: 88448888
www.jollyroom.com/contact



Tuottanut:
Jollyroom AB
Sörredsvägen III SE-418 78
Göteborg SWEDEN
Asiakaspalvelu: 0942415555
www.jollyroom.com/contact



Produziert von:
Jollyroom AB
Sörredsvägen III SE-418 78
Göteborg SWEDEN
Kundenservice:
+4904029997999
www.jollyroom.com/contact